

TRAVERSE BILATERALI

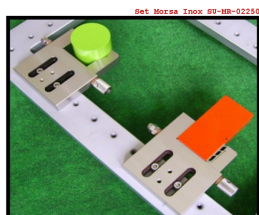

MORSE DI PRECISIONE INOX



KIT FISSAGGIO PER TRAVERSE



SET STAFFE E GANASCE



SET MICRO MORSE

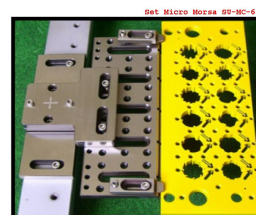



SOMMARIO

TRAVERSA BILATERALE	5
SU-TR-901-2	5
SU-TR-901-2-A	5
SU-TR-901-3	5
SU-TR-901-4	5
SU-TR-901-5-A	5
SU-TR-901-6	5
SU-TR-901-7	5
SU-TR-901-7-A	5
RIEPILOGO TRAVERSE BILATERALI	6
TRAVERSE (RULER) & BLOCCO "V"	7
MORSE DI PRECISIONE INOX	8
SU-MR-1550	8
SU-MR-2250	8
SU-MR-3550	8
MICRO MORSE	10
MICRO SET DI FISSAGGIO	11
GANASCE	12
SU-GN-045	12
SU-GN-045-P	12
SU-GN-050	12
SU-GN-060	12
SU-GN-065	12
SU-GN-120	12
SU-GN-145	12
SU-GN-165-M6	12
SU-GN-170	13
SU-GN-190-M6	13
SU-GN-220	13
SU-GN-260	13
SU-GN-265	13
SU-GN-611	13
SET STAFFE	14
SU-ST-4B72	14
SU-ST-605	14
SU-ST-606	14
SU-ST-607	14
SU-ST-608	14
SU-ST-6B72	14
SU-ST-495	15
SU-ST-395	15
SU-ST-394	15
SU-ST-393	15
SU-ST-392	15
SU-ST-295	15



SOMMARIO

KIT FISSAGGIO PER TRAVERSE	16
SU-KT-015213	16
SU-GN-045	16
SU-GN-220	16
SU-ST-4B72	16
SU-ST-392	16
SU-ST-393	16
SU-ST-606	16
SU-KT-015213-P	17
SU-GN-045-P	17
SU-GN-220	17
SU-ST-4B72	17
SU-ST-392	17
SU-ST-393	17
SU-ST-606	17
SU-KT-015216	18
SU-GN-045	18
SU-GN-065	18
SU-ST-4B72	18
SU-ST-392	18
SU-ST-393	18
SU-ST-606	18
SU-KT-015216-P	19
SU-GN-045-P	19
SU-GN-065	19
SU-GN-4B72	19
SU-ST-392	19
SU-ST-393	19
SU-ST-606	19
SU-KT-015217	20
SU-GN-065	20
SU-GN-170	20
SU-ST-4B72	20
SU-ST-392	20
SU-ST-393	20
SU-ST-606	20
SU-KT-015218	21
SU-KT-015219	22
SU-GN-045	22
SU-GN-170	22
SU-ST-4B72	22
SU-ST-392	22
SU-ST-393	22
SU-ST-606	22
SU-KT-015219-P	23
SU-GN-045-P	23
SU-GN-170	23
SU-ST-4B72	23
SU-ST-392	23
SU-ST-393	23
SU-ST-606	23



SOMMARIO

SU-KT-015221	24
SU-GN-045	24
SU-GN-260	24
SU-ST-4B72	24
SU-ST-392	24
SU-ST-393	24
SU-ST-606	24
SU-KT-015221-P	25
SU-GN-045-P	25
SU-GN-260	25
SU-ST-4B72	25
SU-ST-392	25
SU-ST-393	25
SU-ST-607	25
SU-KT-015222	26
SU-GN-220	26
SU-GN-4B72	26
SU-ST-392	26
SU-ST-393	26
SU-ST-606	26
SU-KT-015223	27
SU-GN-065	27
SU-GN-4B72	27
SU-ST-392	27
SU-ST-393	27
SU-ST-606	27
SU-KT-015227	28
SU-GN-120	28
SU-GN-060	28
SU-ST-4B72	28
SU-ST-392	28
SU-ST-393	28
SU-ST-608	28

TRAVERSA BILATERALE

ITEM	DIM	CARICO MAX (Kg)	A	B	C	D	E	F
SU-TR-901-2	85X510X18+5mm	22	510	85	420	18	5	9
SU-TR-901-2-A	85X580X18+5mm	28	580	85		18	5	9
SU-TR-901-3	90X600X20+5mm	36	660	90		20	5	9
SU-TR-901-4	90X700X22+5mm	43	700	90	590	22	5	9
SU-TR-901-5-A	90X760X22+5mm	53	760	90		22	5	9
SU-TR-901-6	90X800X25+5mm	63	880	90		25	5	9
SU-TR-901-7	95X950X28+5mm	75	950	95	900	28	5	9
SU-TR-901-7-A	95X1200X30+5mm	87	1200	95		30	5	9

Traversa Bilaterale SU-TR-901-n-x

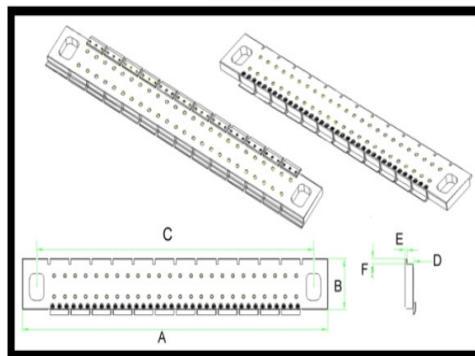

RIEPILOGO TRAVERSE BILATERALI

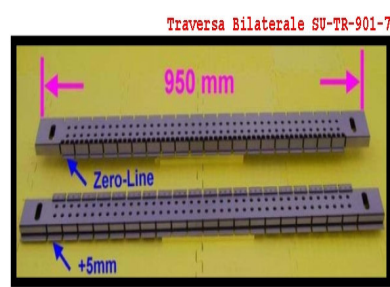
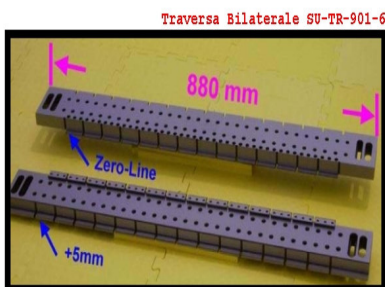
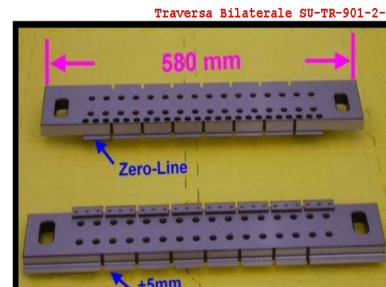
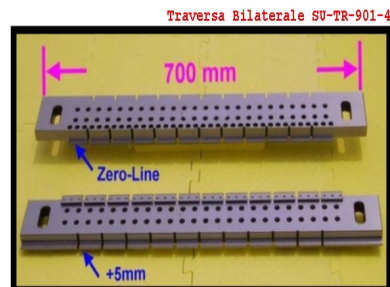
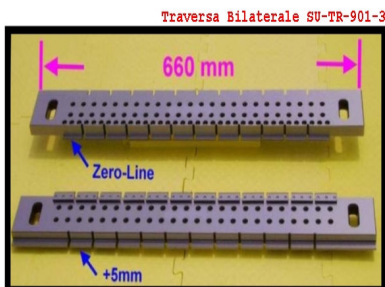
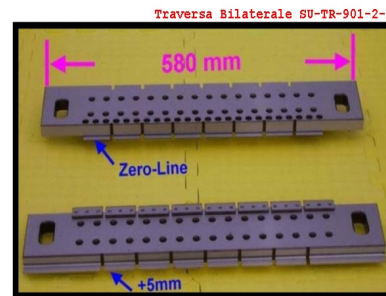
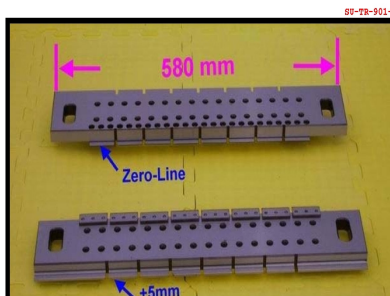
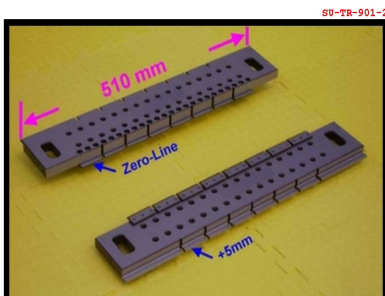

TRAVERSE (RULER) & BLOCCO "V"

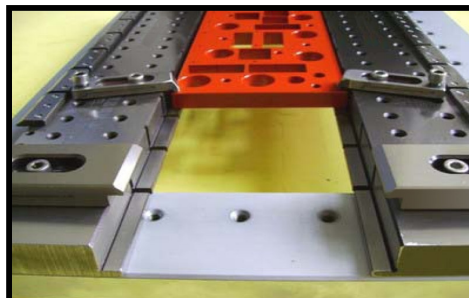
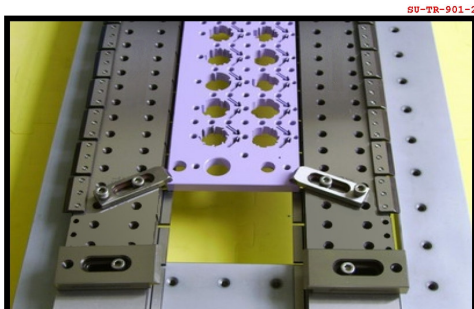

Traverse (Ruler) & Blocco "V"

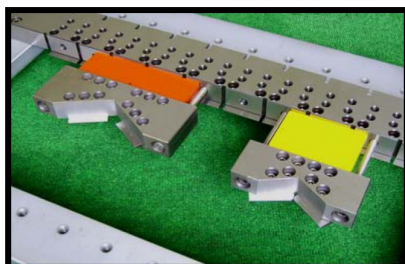

Traverse (Ruler) & Blocco "V"



Traverse (Ruler) & Blocco "V"

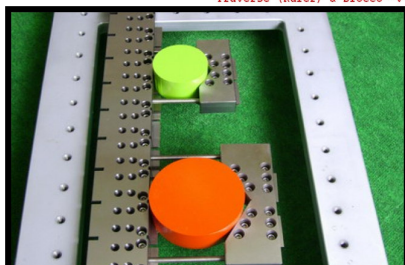

MORSE DI PRECISIONE INOX

CODICE	DIMENSIONI	MASSIMA PORTATA	PRESA LAVORO PZ QUADRI
SU-MR-1550	135X150X15 MM	KG. 4	70 MM
SU-MR-2250	135X150X22 MM	KG. 6	70 MM
SU-MR-3550	135X150X35 MM	KG. 8	70 MM

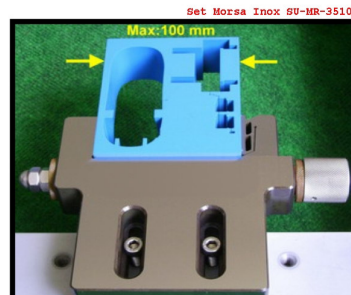
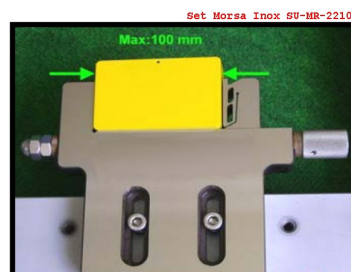
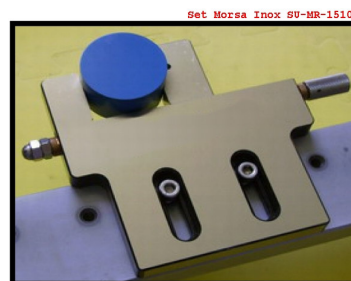

Set morsa Inox SU-MR-1550

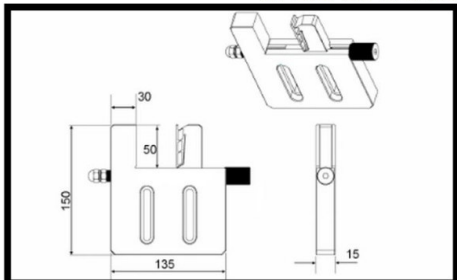

Set Morsa Inox SU-MR-02250

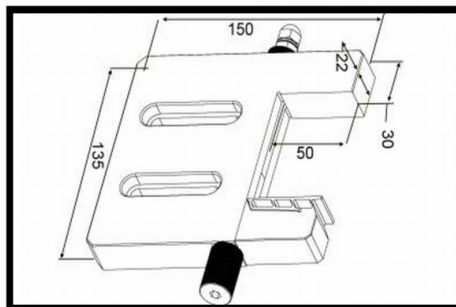

Set Morsa Inox SU-MR-03550

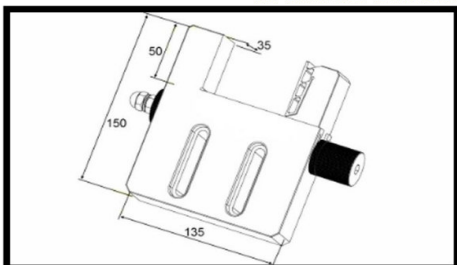

MICRO MORSE

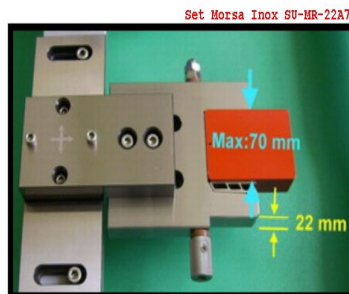
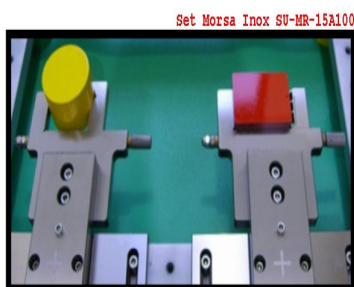
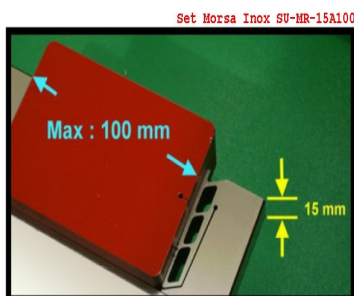
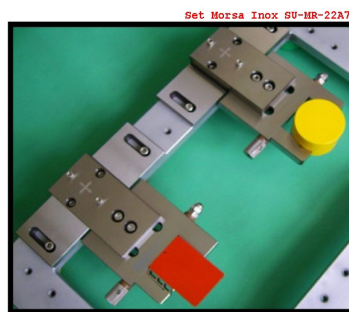
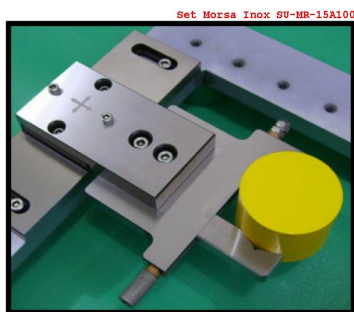

MICRO SET DI FISSAGGIO

Set Micro Morsa SU-MC-368

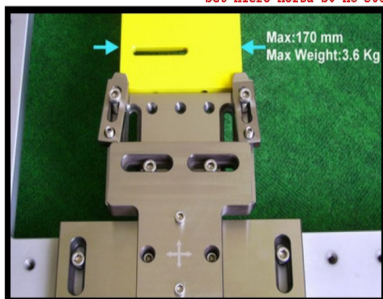

Set Micro Morsa SU-MC-568



Set Micro Morsa SU-MC-668



Set Micro Morsa SU-MC-668

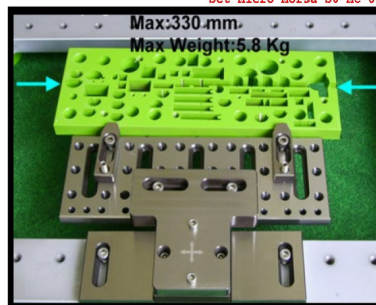

Set Micro Morsa SU-MC-668

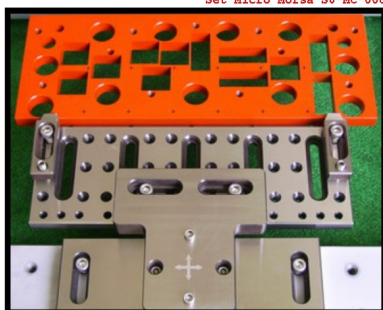

Set Micro Morsa SU-MC-568



GANASCE



SU-GN-045
60X220X20 +5MM (8KG)



SU-GN-045-P
60X220X20 +5MM (8KG)



SU-GN-050
50X120X15 +5MM (8KG)



SU-GN-060
60X120X15 +5MM (8KG)



SU-GN-065
65X120X15 +5MM (8KG)

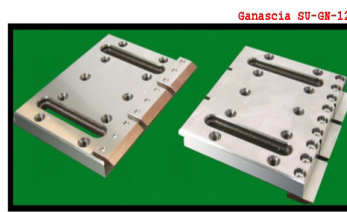

SU-GN-120
120X150X15 +5MM (15KG)



SU-GN-145
100X220X20 +5MM (12KG)



SU-GN-165-M6
65X120X15 +5MM (8KG)



SU-GN-170
65X170X15 +5MM (8KG)



SU-GN-190-M6
120X190X15 +5MM (18,5KG)



SU-GN-220
120X220X15 +5MM (20KG)



SU-GN-260
60X220X22 +5MM (12KG)



SU-GN-265
65X220X15 +5MM (10KG)

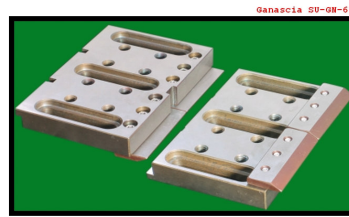

SU-GN-611
85X125X15 +5MM (12KG)

SET STAFFE

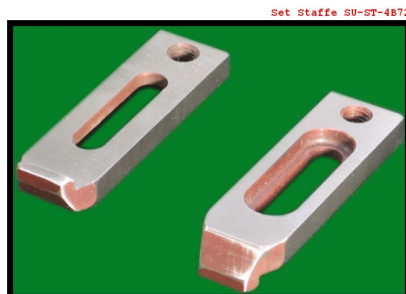

SU-ST-4B72
23X72X4 MM

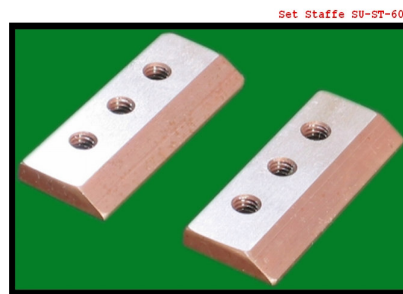

SU-ST-605
23X48X5 MM M6X3



SU-ST-606
23X63X5 MM M5X4



SU-ST-607
28X90X5 MM M5X5



SU-ST-608
23X48X5 MM M5X3



SU-ST-6B72
23X72X6 MM



SU-ST-495
45X95X15 MM



SU-ST-395
23X95X13 MM



SU-ST-394
23X72X13 MM



SU-ST-393
23X95X8 MM



SU-ST-392
23X72X8 MM



SU-ST-295
30X95X20 MM

KIT FISSAGGIO PER TRAVERSE

SU-KT-015213

N	CODICE	QUANTITA'
A	SU-GN-045	2PZ
B	SU-GN-220	1PZ
C	SU-ST-4B72	2PZ
D	SU-ST-392	2PZ
E	SU-ST-393	2PZ
F	SU-ST-606	5PZ
MACCHINE ED APPLICAZIONI		TUTTI I TIPI DI EDM A FILO

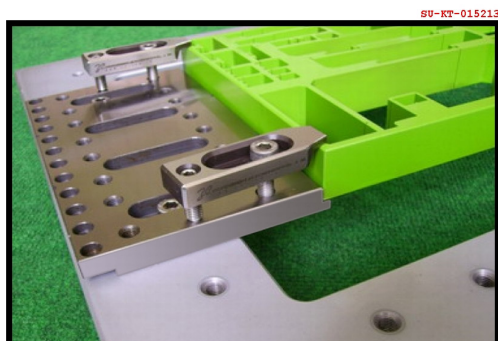
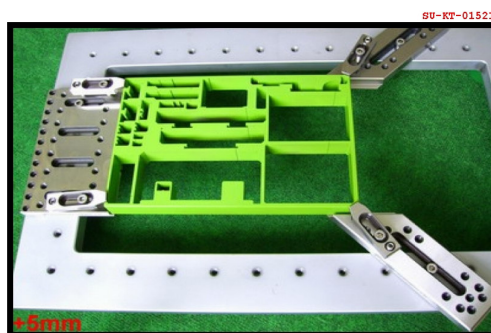
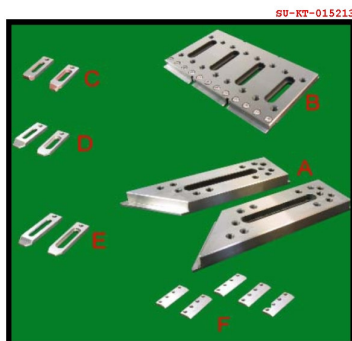
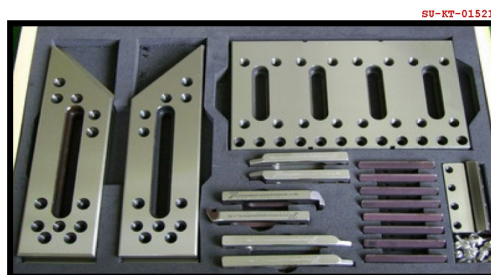

SU-KT-015213-P

N	CODICE	QUANTITA'
A	SU-GN-045-P	2PZ
B	SU-GN-220	1PZ
C	SU-ST-4B72	2PZ
D	SU-ST-392	2PZ
E	SU-ST-393	2PZ
F	SU-ST-606	5PZ
G		
MACCHINE ED APPLICAZIONI		TUTTI I TIPI DI EDM A FILO

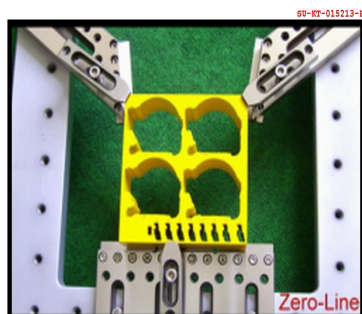
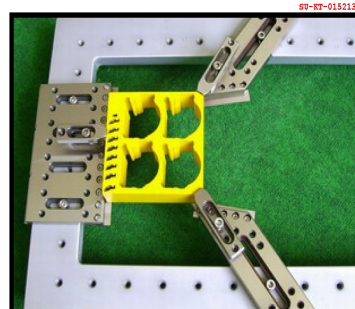
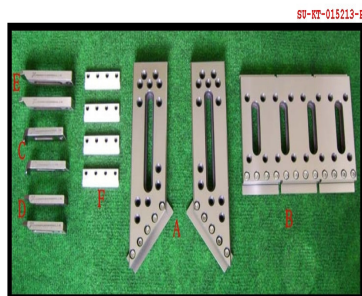

SU-KT-015216

N	CODICE	QUANTITA'
A	SU-GN-045	2PZ
B	SU-GN-065	3PZ
C	SU-ST-4B72	2PZ
D	SU-ST-392	2PZ
E	SU-ST-393	2PZ
F	SU-ST-606	5PZ
MACCHINE ED APPLICAZIONI		TUTTI I TIPI DI EDM A FILO

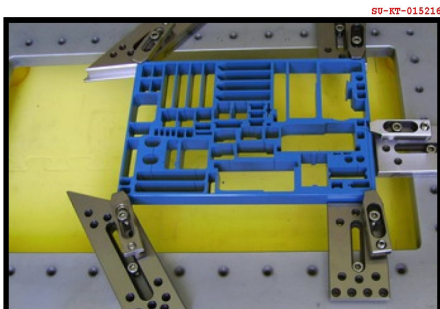
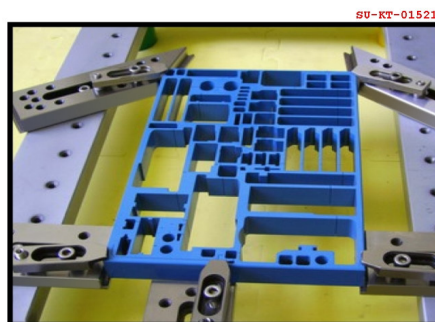

SU-KT-015216-P

N	CODICE	QUANTITA'
A	SU-GN-045-P	2PZ
B	SU-GN-065	3PZ
C	SU-GN-4B72	2PZ
D	SU-ST-392	2PZ
E	SU-ST-393	2PZ
F	SU-ST-606	4PZ
G		
MACCHINE ED APPLICAZIONI		TUTTI I TIPI DI EDM A FILO

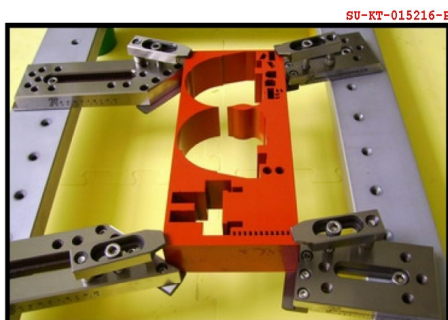
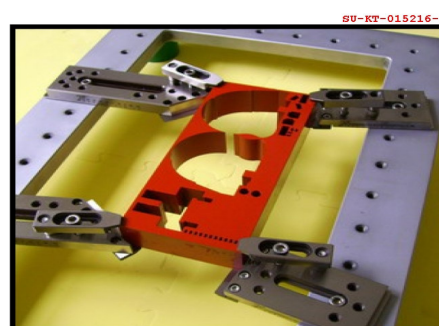
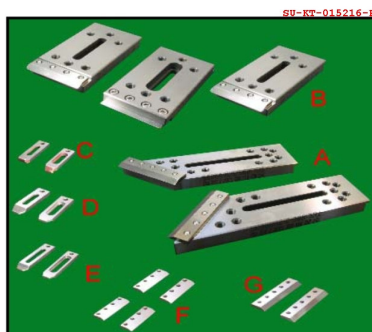

SU-KT-015217

N	CODICE	QUANTITA'
A	SU-GN-065	3PZ
B	SU-GN-170	2PZ
C	SU-ST-4B72	2PZ
D	SU-ST-392	2PZ
E	SU-ST-393	2PZ
F	SU-ST-606	7PZ
G		
MACCHINE ED APPLICAZIONI		TUTTI I TIPI DI EDM A FILO

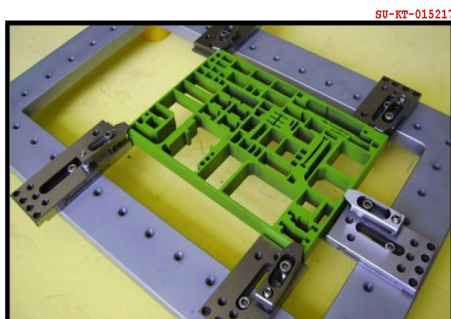
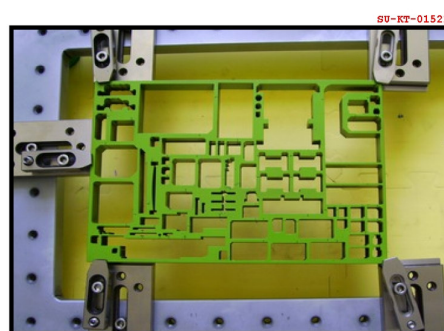
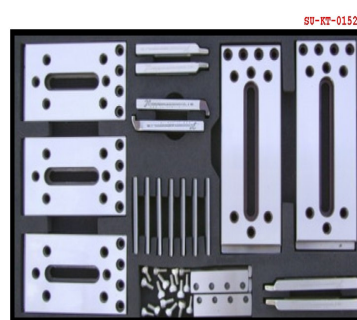
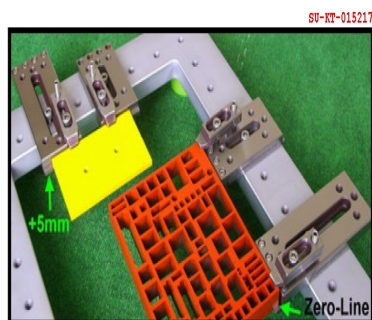



SU-KT-015218

N	CODICE	QUANTITA'
A		
B		
C		
D		
E		
F		
G		
MACCHINE ED APPLICAZIONI		TUTTI I TIPI DI EDM A FILO

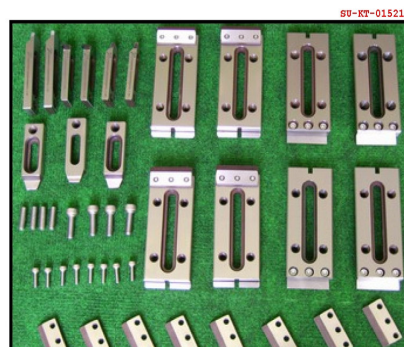

SU-KT-015219

N	CODICE	QUANTITA'
A	SU-GN-045	2PZ
B	SU-GN-170	2PZ
C	SU-ST-4B72	2PZ
D	SU-ST-392	2PZ
E	SU-ST-393	2PZ
F	SU-ST-606	6PZ
MACCHINE ED APPLICAZIONI		TUTTI I TIPI DI EDM A FILO

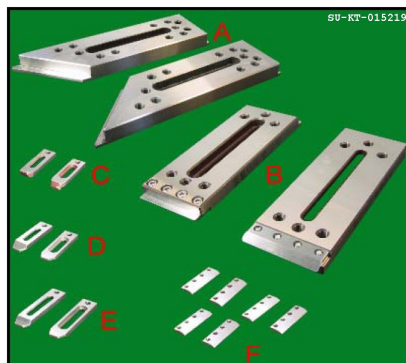
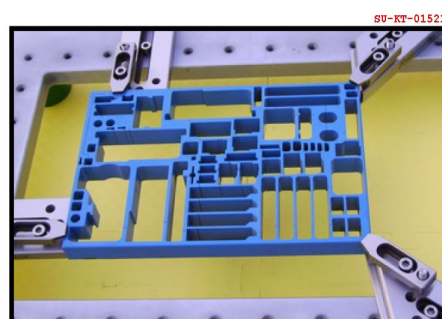
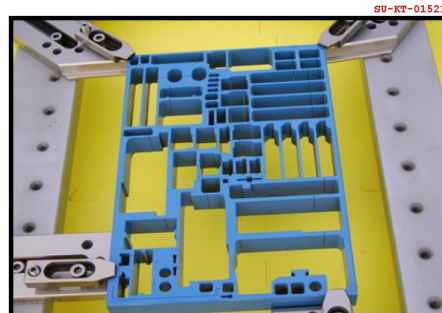
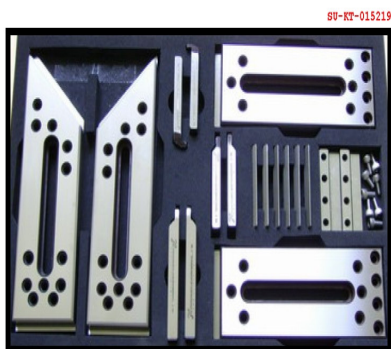

SU-KT-015219-P

N	CODICE	QUANTITA'
A	SU-GN-045-P	2PZ
B	SU-GN-170	2PZ
C	SU-ST-4B72	2PZ
D	SU-ST-392	2PZ
E	SU-ST-393	4PZ
F	SU-ST-606	6PZ
G		
MACCHINE ED APPLICAZIONI		TUTTI I TIPI DI EDM A FILO

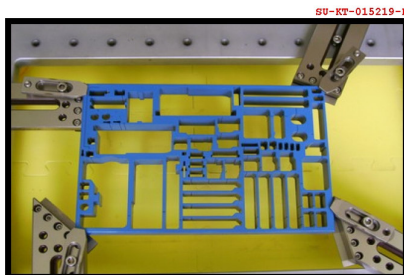
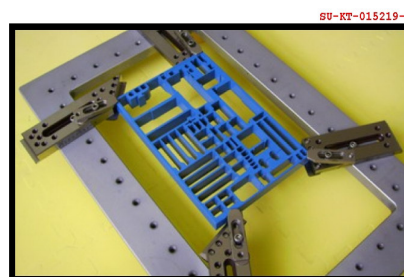
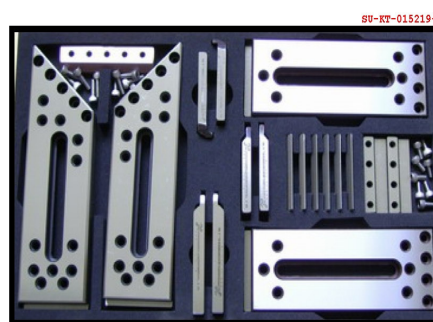

SU-KT-015221

N	CODICE	QUANTITA'
A	SU-GN-045	2PZ
B	SU-GN-260	2PZ
C	SU-ST-4B72	2PZ
D	SU-ST-392	2PZ
E	SU-ST-393	2PZ
F	SU-ST-606	6PZ
G		
MACCHINE ED APPLICAZIONI		TUTTI I TIPI DI EDM A FILO

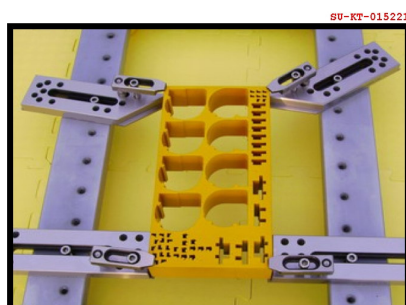
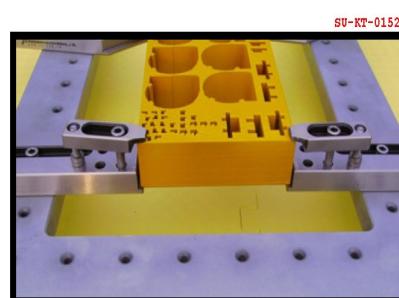

SU-KT-015221-P

N	CODICE	QUANTITA'
A	SU-GN-045-P	2PZ
B	SU-GN-260	2PZ
C	SU-ST-4B72	2PZ
D	SU-ST-392	2PZ
E	SU-ST-393	2PZ
F	SU-ST-607	4PZ
G		
MACCHINE ED APPLICAZIONI		TUTTI I TIPI DI EDM A FILO

SU-KT-015221-P

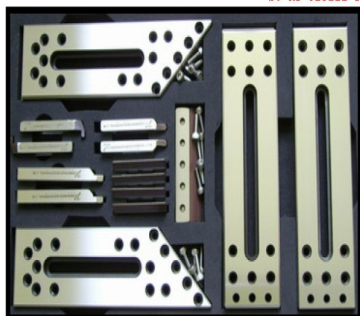

SU-KT-015221-P



SU-KT-015221-P

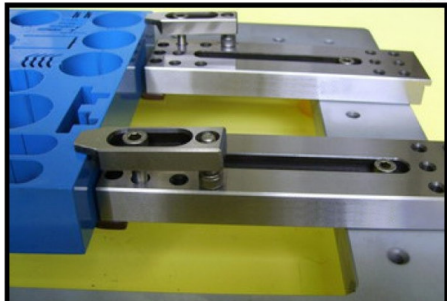

SU-KT-015221-P

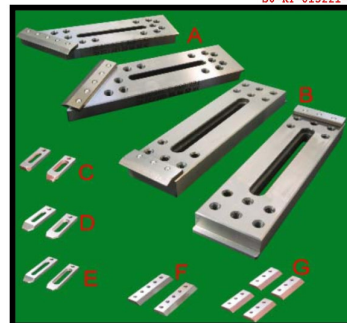

SU-KT-015221-P

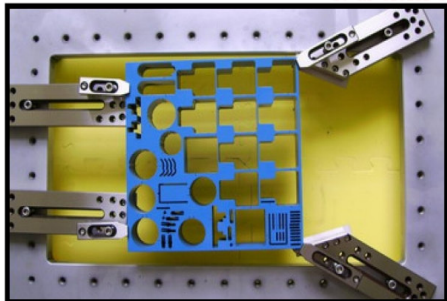

SU-KT-015222

N	CODICE	QUANTITA'
A	SU-GN-220	2PZ
B	SU-GN-4B72	2PZ
C	SU-ST-392	2PZ
D	SU-ST-393	2PZ
E	SU-ST-606	8PZ
F		
G		
MACCHINE ED APPLICAZIONI		TUTTI I TIPI DI EDM A FILO

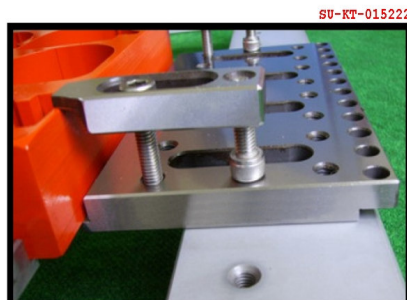
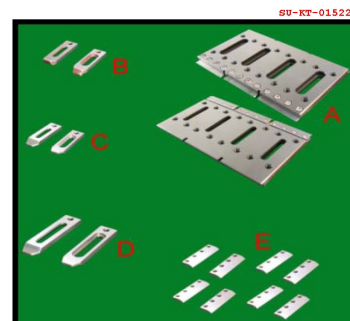
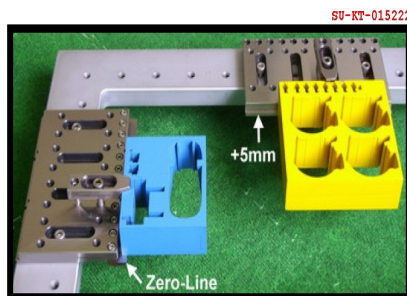
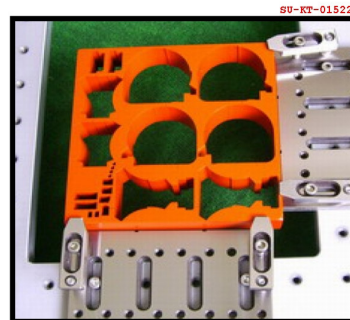
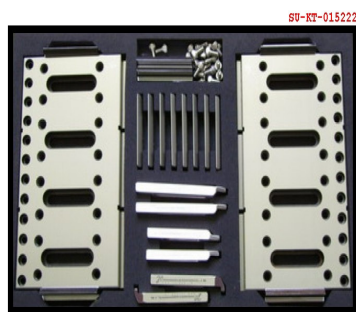

SU-KT-015223

N	CODICE	QUANTITA'
A	SU-GN-065	6PZ
B	SU-GN-4B72	2PZ
C	SU-ST-392	2PZ
D	SU-ST-393	2PZ
E	SU-ST-606	8PZ
F		
G		
MACCHINE ED APPLICAZIONI		TUTTI I TIPI DI EDM A FILO

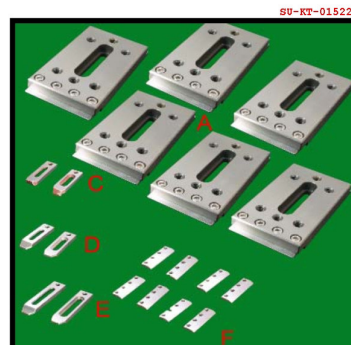
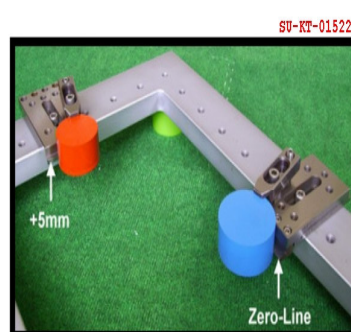
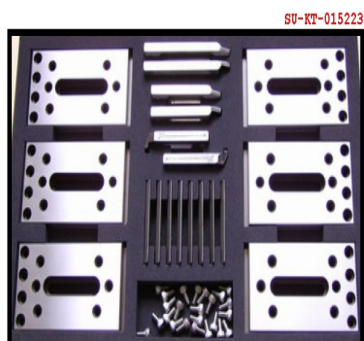

SU-KT-015227

N	CODICE	QUANTITA'
A	SU-GN-120	2PZ
B	SU-GN-060	2PZ
C	SU-ST-4B72	2PZ
D	SU-ST-392	2PZ
E	SU-ST-393	2PZ
F	SU-ST-608	8PZ
G		
MACCHINE ED APPLICAZIONI		TUTTI I TIPI DI EDM A FILO

